

## The Vertical Urban Factory as a Concept for Mixed Use in Future Cities

*Edeltraud Haselsteiner, Lisa-Maria Grob, Harald Frey, Verena Madner, Barbara Laa, Katja Schwaigerlehner*

(DI Dr. Edeltraud Haselsteiner, Urbanity - Architektur, Kunst, Kultur und Sprache, Märzstraße 158/20, 1140 Vienna, edeltraud.haselsteiner@aon.at)

(Lisa-Maria Grob, LL.M., WU Vienna, Research Institute for Urban Management and Governance, Welthandelsplatz 1, 1020 Vienna, lisa-maria.grob@wu.ac.at)

(DI Dr. Harald Frey, TU Vienna, Research Center of Transport Planning and Traffic Engineering, Gußhausstraße 30, 1040 Vienna, harald.frey@tuwien.ac.at)

(Univ.Prof. Dr. Verena Madner, WU Vienna, Research Institute for Urban Management and Governance, Welthandelsplatz 1, 1020 Vienna, verena.madner@wu.ac.at)

(DI Barbara Laa BSc., TU Vienna, Research Center of Transport Planning and Traffic Engineering, Gußhausstraße 30, 1040 Vienna, barbara.laa@tuwien.ac.at)

(DI Katja Schwaigerlehner BSc., Urbanity - Architektur, Kunst, Kultur und Sprache, Märzstraße 158/20, 1140 Vienna,

### 1 ABSTRACT

In many European cities, production in backyards and inner city multi-storey buildings had been part of the cityscape since industrialisation. However, since then, such production spaces have continued to move to greenfield sites and have thereby created monofunctional industrial areas in the periphery. While the drivers for this ‘spatial decoupling’ are manifold (e.g. economies of scale, mass motorization, land prices, regulatory restrictions), strategies to influence and counteract segregation remain scarce. Mixing residential and working areas contributes significantly to energy-efficient urban development and the achievement of ambitious smart city goals and a lively urban fabric.

While the digital transformation of industrial production (‘Industry 4.0’) seems to prepare the return of urban industry to mixed-use neighbourhoods, there are still considerable obstacles. Concepts to make production in the city attractive again for companies are currently still the exception. Nonetheless there are approaches in European cities: Berlin adopted a masterplan (‘Masterplan Industriestadt Berlin 2018-2021’) to improve the framework conditions for industrial companies. The ‘Regional Sustainable Development Plan’ of the city of Brussels provides support for urban production by planning instruments, such as ‘ZEMU’ zones; these zones enable a more intensive and mixed-use of industrial land. The spatial development strategy in London, known as ‘the London Plan’, contains provision for the protection of industrial land within the city.

Against this background, our research project ‘Vertical Urban Factory’ analyses architectural, legal and transportation parameters for mixing working and residential areas in cities. For the project, we build on the concept of vertical urban factories and explore the potentials of reintegrating multi-storey production in European cities. In doing so, we use Vienna as an example of a typical European city which has recently developed a planning strategy for the ‘Productive City’. Based on results from basic scientific research, case studies, best practice examples and numerous interviews with companies, we ultimately develop five innovative, city-compatible and vertically organized building prototypes of ‘vertical urban factories’. These consider the existing urban structure, legal restrictions, global and local objectives, production needs and urban freight logistics.

In the present paper, we will give an overview of key results from our project. In doing so, we will introduce essential aspects and characteristics of a ‘productive city’. Based on this understanding, we will first discuss architectural parameters and transportation aspects of reintegrating production in cities illustrated by three prototypes. Then, we will engage with legal approaches (e.g. financial incentives, spatial planning instruments) and their framework conditions relevant for enabling production in the city.

Keywords: mixed-use, urban factory, productive city, urban production, regional planning

### 2 INTRODUCTION

Essential drivers for the relocation of city production premises to monofunctional industrial areas are, beside high land prices and regulatory restrictions, the change in production (from individual manufacturing to mass production) and in consumption over the last centuries. The loss of operating areas and thus of urban workplaces can also be traced back to the increase in the city population, which pressures cities to develop new locations for residential construction. In Vienna, for example, since 2001 the share of space of

manufacturing enterprises has declined by 16.5 % that of industrial areas by even 30 % (Municipal Department 18, 2017).

In light of the growing scarcity of urban space, measures against a spatial separation of designated living and working areas are urgently required. The consequence of spatial decoupling is that potential synergies cannot be exploited sustainably (e.g. energy/waste heat utilization, cycle and cascade economy, urban value creation, micro-economic local networks). Furthermore, such a segregation induces motorised individual transport, which leads in the end to higher CO<sub>2</sub> emissions. A mixed-use structure can therefore help cities on their way to achieve the transformation towards a low-carbon economy.

Industrial production has recently become increasingly efficient, together with lower pollutant and noise emissions. Companies in urban areas benefit from the urban infrastructure, the spatial proximity to customers, training centers, the availability of personnel, especially among specialist staff, as well as the advantages of cooperation with research institutions (universities, universities of applied sciences) and the formation of production networks. In particular the formation of innovative production networks, also known as 'urban manufacturing', is increasingly being perceived as an attractive form of city-compatible production in the immediate vicinity of the consumer. Nowadays, business and industry have modern production methods that can be integrated well in an urban context. Industry 4.0 summarizes production processes that are largely automated or digitized. At the same time, mass production is increasingly being replaced by flexible production in many manufacturing areas. 'Production on Demand', that means not producing on stock and warehousing but adapted to the current demand, opens up new possibilities to produce also in more urban areas.

In 2014, Vienna introduced the 'Urban Development Plan Vienna – STEP 2025', which contains targets to be achieved by 2025 (Municipal Department 18, 2014). The STEP 2025 is supplemented by various specialist concepts, e.g. 'Productive City' and 'Public Space' concepts. The 'Productive City' concept (Municipal Department 18, 2017) contains areas that should be kept available to promote urban production. Further, the concept provides a city map with possible future production locations. These designated areas can be used as the basis for the location of prototypes of vertical urban production.

The vertical production promotes building density and thus also an efficient and city-compatible design of logistics systems and intelligent transport and traffic concepts. However, there is also the challenge of integrating freight transport necessary for urban production into liveable cities. We developed prototypes for vertical urban factories that reflect the challenges and show possible solutions. A more detailed analysis of the transportation parameters for the 'Vertical Urban Factory' project is presented in the paper of Frey H. et al (in press).

### 3 PROTOTYPES

For our purposes, the urban structure of Vienna can be divided into three different types of areas for production facilities: integrated individual production facility, mixed commercial area and industrial-commercial area. These types correspond to the areas defined in the city's thematic concept 'Productive City' (Municipal Department 18, 2017). The integrated individual production facility is a single factory, embedded in a dense urban structure with mainly residential use. Existing factories of this type are usually historic ones that were built in an industrial area where residential buildings have approached with city expansion. Mixed commercial areas combine residential, commercial and industrial use. Such areas have generally been densified more recently and still show lower building density. Industrial-commercial areas can be found usually on the outskirts of the city. They have no residential buildings, mostly hall constructions and spacious traffic areas.

We present three different prototypes of vertical urban factories. They reflect common challenges according to the type of area as well as suitable solutions. Certain principles of transport planning are part of all the prototypes. These include priority access by public transport, walking and cycling and bicycle parking close to the entrance. Yellow shaded areas inside the buildings are 'access cores' featuring logistics areas, elevators and staircases. Underground parking was included in the prototypes to account for existing laws requiring car parking.<sup>1</sup> We would like to state that on-site parking is not in line with global and city

---

<sup>1</sup> For example, Gesetz über das Einstellen von Kraftfahrzeugen, kraftbetriebene Parkeinrichtungen und Tankstellen in Wien (Wiener Garagensetz 2008), State Law Gazette I 2009/34, last amended by State Law Gazette I 2018/71.

objectives to reduce private car use. It creates an advantage for the use of private cars compared to public transport (see e.g. Parikesit D., 1996; Knoflacher H., 2006 and Emberger G., Pfaffenbichler P., 2017).

### 3.1 Integrated individual production facility

Prototype 1 represents the variant of a commercial courtyard. Several small and medium-sized businesses share a building or a building complex as tenants. Suitable locations are mixed urban areas with good connections to urban infrastructure and customer proximity. Commercial estates are rented by very different companies from trade, craft, service and the creative sector. Advantages result from the possibility of synergistic use of rooms (e.g. meeting and event rooms), resources (e.g. raw materials) or sharing of transport, storage and logistics infrastructure. A focus on certain industries (e.g. recycling/re-use; food direct marketer) could further increase the attractiveness. Fitness, sport and leisure facilities or co-working spaces could be provided as a structural separation from the adjacent residential development - here in the crossbar.

A particular challenge of this prototype is the conflict of space in the densely built environment. One solution for this are sharing concepts. In our prototype, the courtyard serves as a shared logistics and meeting area. Large delivery trucks can access the courtyard in a one-way manner, though use of smaller vehicles such as cargo bikes is encouraged by designated cargo bike parking. Outside the building, in public space, is a 'multifunctional lane' which can serve as delivery zone, parking space or seating area depending on the time of day and year. Figure 1 to Figure 4 show the 3D visualization, urban structure, material and people flows and transportation concept of the prototype.

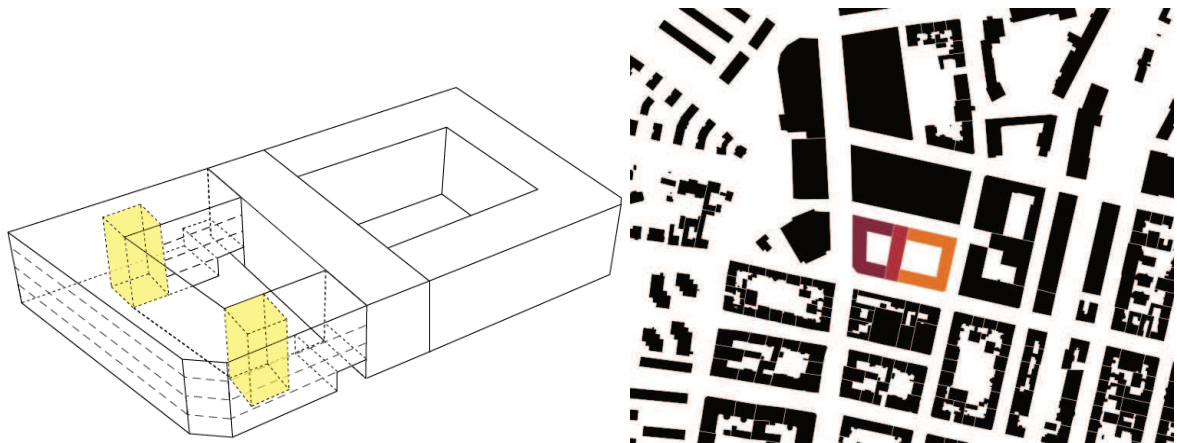

Figure 1 (left): 3D visualization prototype integrated individual production facility. Figure 2 (right): Urban structure integrated individual production facility

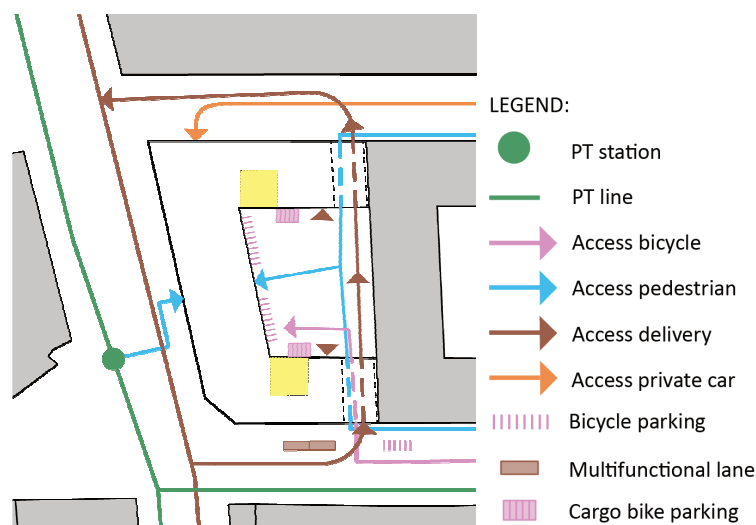

Figure 3: Transportation concept integrated individual production facility

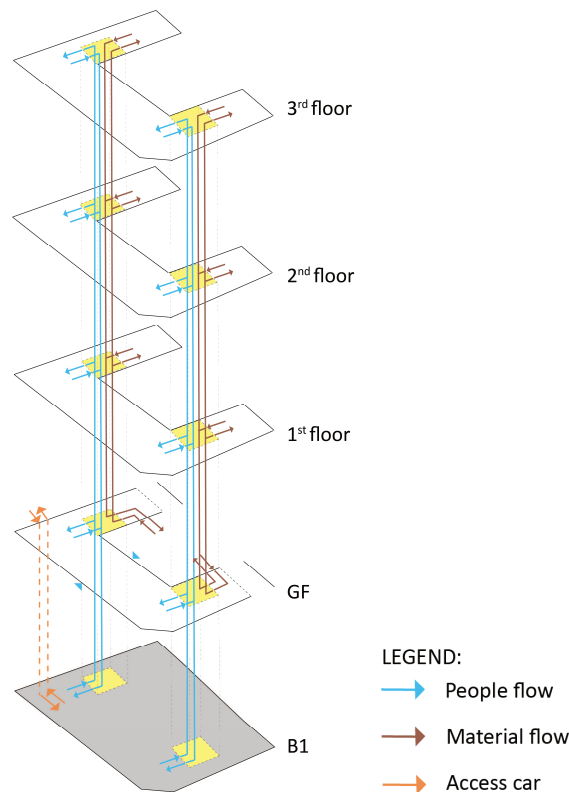

Figure 4: People and material flow integrated individual production facility. GF...Ground floor, B...Basement

### 3.2 High-Rise Building

Prototype 2 is planned as a high-rise building and therefore as a prototype for low space availability. Similar to the industrial estate, several companies share the available production space as tenants. Usable space can be rented to different companies per floor. Each level offers the possibility of its own access. Ceiling heights of up to 6 meters allow individual expansion and installation of mezzanines. Financing, construction and administration are carried out by operating companies, as is the case with commercial yards. This prototype has its location in the outskirts with large-volume buildings, e.g. urban expansion areas from the 1960s. As a ‘catalyst’, the production building can contribute to diversity and a mix of uses for the city quarter. Start-up companies from all industries that appreciate the proximity to research and educational institutions are particularly addressed. Similar to the commercial center, there are synergies for the joint use of rooms, resources and infrastructure. Building sections with multifunctional use (e.g. cultural and event rooms) are conceivable as a structural separation from residential construction.

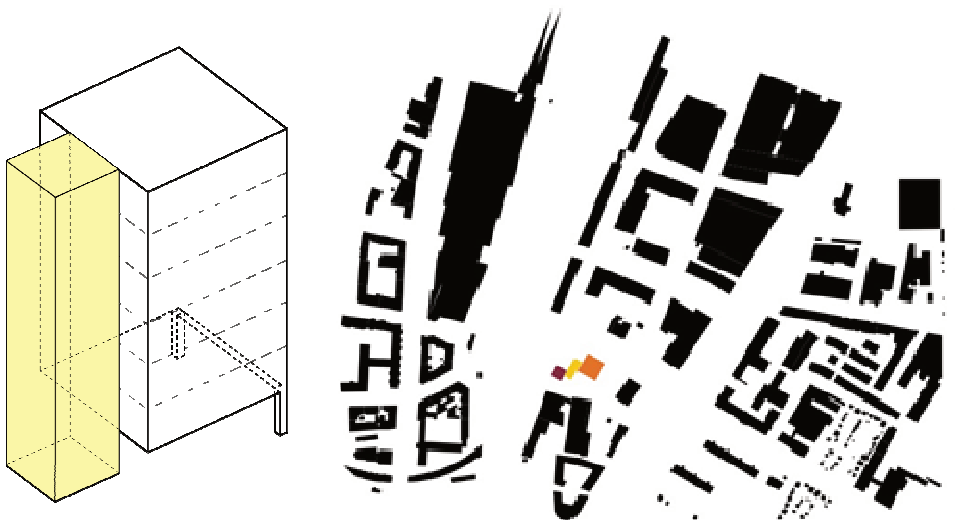

Figure 5 (left): 3D visualization prototype high-rise building. Figure 6 (right): Urban structure high-rise building

For this prototype, we developed a concept where all logistics areas are shared and placed at the open ground floor level in order to save space. Access for people and delivery vehicles is located directly at the ‘access core‘ (marked yellow). Given enough space at the back of the building, even large delivery trucks are able to access. Parking spaces for smaller vehicles such as cargo bicycles are located close to the delivery access, next to the logistics and storage area.

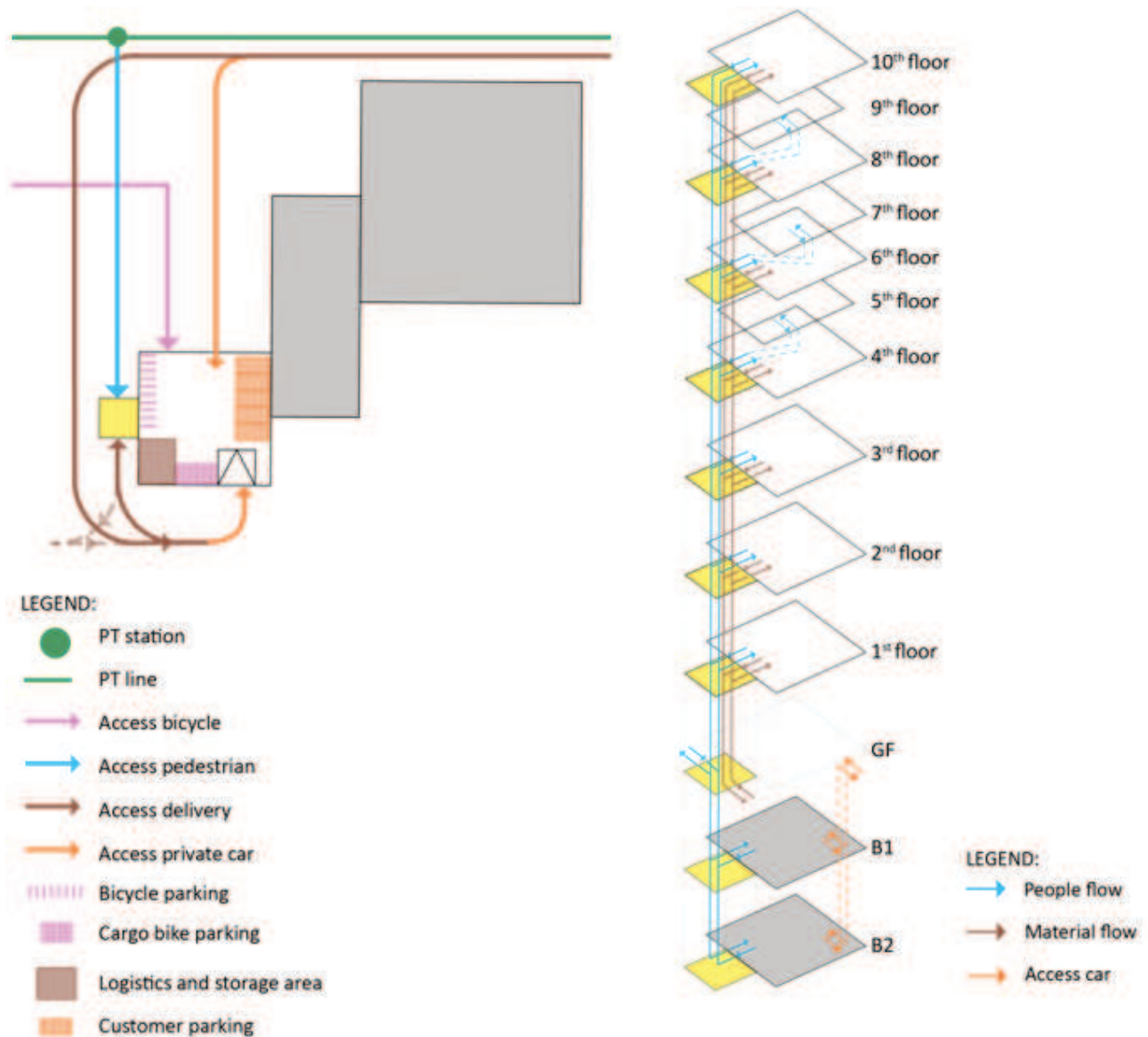

Figure 7 (left): Transportation concept high-rise building. Figure 8 (right): People and material flow integrated high-rise building. GF...Ground floor, B...Basement

### 3.3 Row Building

Prototype 3 is designed for locations in mixed commercial areas and for companies with high requirements of usable space. In addition, future expansion of operations should be secured by potential areas. The proximity and infrastructural connection to specific research sectors (e.g. pharmaceuticals, health and medicine) could represent an additional benefit. The row type takes into account several parallel production processes in different building sections. The floor plans can be flexibly divided into smaller units. The building complex is spatially distant from the surrounding (residential) buildings and clearly delimited. A common use of company social infrastructure (e.g. event rooms, company restaurant) or green and open spaces in between could be planned. Unused waste heat potential from production could supply surrounding residential buildings. Depending on the industry, a high potential for circular economy and recycling of residues could also be generated.

This prototype serves as a kind of buffer between the residential area on one side of the building and a transportation axis on the other side, such as train tracks or a high-level street. Access for pedestrians and

cyclists is given at the residential side whereas access for delivery vehicles and space for logistics areas are located at the side of the transportation axis. This way, residents and people accessing the building are shielded from noise and exhausts.

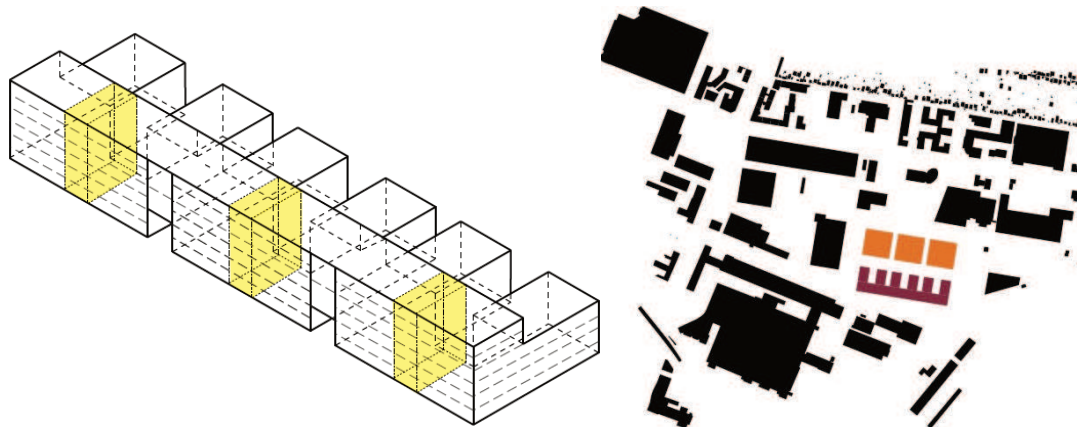

Figure 9 (left): 3D visualization prototype row building. Figure 10 (right): Urban structure row building

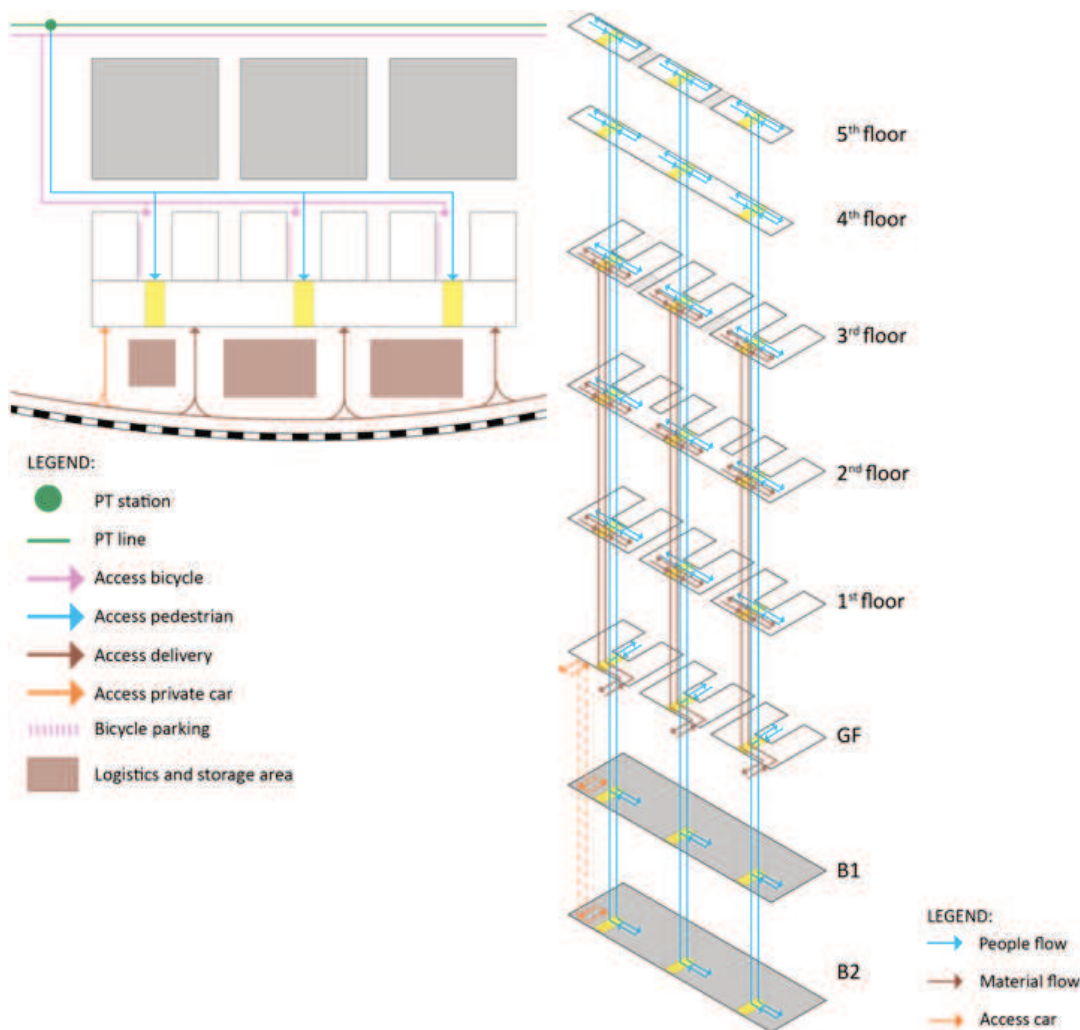

Figure 11 (left): Transportation concept row building. Figure 12 (right): People and material flow row building. GF...Ground floor, B...Basement

#### 4 LEGAL APPROACHES FOR INTERMIXING WORKING AND HOUSING

The intermixing of working and housing contributes essentially to an innovative and sustainable urban development. Scarcity of space increasingly leads to calls for developing mixed-use structures and stacked functions allowing to achieve synergies in the sense of the urban planning model of the ‘city of short distances’ (approaches for achieving a ‘city of short distances’, see Madner V., Grob L.-M., 2019).

In the light of these considerations, we first focused on identifying legal requirements for the promotion of a mixed-use structure and the (vertical) production within the city of Vienna. We found that there are no provisions explicitly prescribing the intermixing of working and housing. However, at the same time, we found that certain factors including legal requirements in practice indeed lead to the emergence of a mixed-use structure. These factors include financial measures, regional and local planning instruments as well as approval procedures. Against this background, this chapter gives an overview of potential factors including legal requirements, which (indirectly) affect the emergence of mixed-use structures.

One factor, which may have an impact on the emergence of mixed-use structures, are financial incentives. These include, in particular, numerous tax measures such as the commuter tax allowance or various municipal taxes, e.g. the property tax. The purpose of the commuter tax allowance is to compensate employees' traffic expenses for their distance between workplace and residence, which means that the existing tax benefit does not create an incentive for achieving mixed-used neighbourhoods. Another potentially relevant instrument under Austrian tax law is the so-called 'Verkehrsanschlussabgabe': Municipalities are entitled to levy charges on businesses in order to cover costs of connecting their premises to public transport. In this way, businesses profiting from local public transport – in particular those built on greenfield sites such as shopping centres or leisure parks – are supposed to contribute to the costs of such public transport. However, as municipalities compete to attract businesses, no municipality in Austria has so far levied such a charge. Apart from taxes, relevant financial measures also include subsidies. In fact, there exist numerous subsidies, which indirectly influence the intermixing of working and housing as well as the production within the city.

Another factor, which has a significant impact on (the prevention of) 'spatial decoupling' concerns the field of spatial planning. In Austria, the legislative and executive power in this area lies largely with the Länder (states). The states adopt not only rules laying down principles and objectives for regional planning strategies and concepts but also legal provisions on land-use plans.

As regards planning strategies, the city of Vienna (which is also a state with legislative powers) recently introduced the 'Productive City' concept (Municipal Department 18, 2017). This overarching strategy, underlines the importance of production within the city. The aim of the concept is to strengthen the urban productive sector by providing and maintaining suitable and sufficient production areas. To this end, the 'Productive City' concept introduces three types of areas, serving as a long-term, spatial orientation for the city administration in order to secure existing and develop new business locations. The three different types are industrial-commercial area, mixed commercial area and integrated individual production facility. The categories differ with a view to permissible usage and the following parameters include location, infrastructure, emissions and mobility. Despite the clear commitment to provide spatial capacities for production sites within the city of Vienna, it should be noted that the 'Productive City' concept is not legally binding for further planning instruments. However, the concept represents a strategic orientation function for the planning authority in Vienna (for details see Donner C. et al, 2014).

As regards legally binding planning instruments, the land-use plan has to conform to the requirements stipulated in Vienna's spatial planning act ('Bauordnung für Wien').<sup>2</sup> This act determines permitted land uses and distinguishes between different zoning types, for example residential zones, commercial zones, mixed zones and industrial zones. These zones differ with regard to permissible uses and the extent of pollution (noise, dust, smell etc.). Whereas residential zones are mainly suited for housing, mixed zones combine usage for residential and production purposes.

On this basis, the municipal council of Vienna enacts the (legally binding) land-use plan, designating which areas fall under which of the different land-use plan zones. Thus, it becomes obvious that the local planning authority has considerable influence on the mixing of working and housing within the city.

Against this background, our legal analysis showed that mixed-use neighbourhoods can be achieved both by designating a mixed zone next to an industrial zone or within one type of zone, by differentiating between either floor levels or adjacent properties (for details see Grob, 2018). However, the spatial planning act permits a mixed-use structure only within residential zones and mixed zones. In this regard, it is essential that buildings within these two zoning types must be compatible with the intended usage and must not lead

<sup>2</sup> Wiener Stadtentwicklungs-, Stadtplanungs- und Baugesetzbuch (Bauordnung für Wien), State Law Gazette I 1930/11, last amended by State Law Gazette I 2018/71.

to any dangers and excessive disturbances for the neighbours. In this regard, it is noteworthy that the two zoning types for mixed-use structures in Vienna – residential zones and mixed zones – correspond approximately to the mixed commercial areas and integrated individual production facility identified in the ‘Productive City’ concept. Moreover, it deserves mention that the Vienna land-use plan also contains binding specifications for building development, such as building height or building density, which have significant effect for vertical production processes.

In light of the above, it becomes clear that spatial planning has a great potential for counteracting spatial segregation, in particular at the local planning level. However, it has to be kept in mind that property owners are not obliged to build and thus to actually realise the intended usages laid down in the land-use plan. Therefore, municipalities often have to designate additional (residential) zones – often in the periphery – to cover the demand for housing and working space. This often undermines the realisation of mixed-use neighbourhoods and a lively urban fabric. In order to counteract this problem and prevent further urban sprawl, municipalities can decide to attach a time limit to the designation of (residential) zones. If the newly designated residential zone is not used accordingly within the limited period (i.e. no buildings are being built), the municipality may alter zoning type, e.g. from residential zone to green zone, where neither residential nor production usage is permitted.

The actual implementation of urban production – ie the construction or amendment of business premises – requires special permits. Due to the federal distribution of competences anchored in the Austrian constitution, both the federal government (as legislator for industrial law) and the federal states (as legislators for building law) may enact regulations regarding the development of urban production sites. Usually both a building permit and an industrial installation permit are required.

The building permit procedure reviews inter alia whether the newly constructed or amended building is in compliance with the demands set out in the land-use plan, e.g. zoning type, building height and density. In addition, the building laws aim to protect residential neighbours from industrial or commercial pollution (noise, dust, smell etc.). Furthermore – according to the case law of the Constitutional Court that has been taken up by some state legislators (including Vienna) – also urban producers have the right to take legal action against new residential developments that may cause conflict because of their proximity to the production site.

The development and amendment of urban production sites usually requires an industrial installation permit. This permit procedure also aims to protect neighbours either from a threat to their life or health, or from nuisances through noise, odours or other emissions. Although urban producers have the right to take legal action against new residential developments in the context of the building permit procedure, at the same time the industrial installation permitting procedure can result in obligations to restrict production to protect health interests of residential neighbours (enacted by industrial installation law authority). This lack of legal certainty is one of the drivers for the relocation of production to greenfields as well as industrial and commercial parks working against mixed-use structures.

## 5 CONCLUSION

The previous explanations have shown modular models of vertically organized and urban integrated building typologies. Depending on the type of area, type of development or infrastructural conditions, very different space-saving concepts are possible, which can be adapted according to company-specific requirements. Space requirements, building equipment, spatial planning aspects, options for mixed use with residential construction, energy potential, noise and emissions protection, legal aspects as well as aspects of traffic and logistics were included in the considerations. These model types show that the multi-storey construction is a real viable alternative for limited space and urban production. The compact design and organization of the production processes in a multi-storey building is not only possible from an economic point of view, depending on the type of production, but is also generally more cost-effective to implement.

Regarding transportation parameters, vertical urban factories in densely built-up areas would best fulfil policy objectives. There are restrictions for motorized individual transport but in view of new production techniques and smaller lot sizes, smaller vehicles, alternative engines and cargo bikes could play a major role in the future of urban freight and render production more compatible with the urban environment. A high



potential for vertical urban factories can also be seen in mixed commercial areas with space reserves that will be subject to densification.

The analysis of the legal framework shows that the approaches for the intermixing of working and residential usage are manifold: The relevant legal provisions range from financial incentives over strategic planning, such as the 'Productive City' concept and legally binding determinations in the land-use plan to legal requirements regarding the approval procedures. We found that the Austrian tax law provides no incentives for businesses to contribute to mixed-use neighbourhoods so far. With the instrument of the 'Verkehrsanschlussabgabe', the municipalities would have a direct steering effect on the development of mixed-use structures; however, this "lever" is currently not made use of. As a result of the federal distribution of competences parallel approval procedures are required, such as building permit and industrial installation permit procedures. Approaches for their coordination as well as for overcoming duplication are available, e.g. common procedure. The conflict-free (re)integration of (vertical) production in the city may indeed represent a challenge, especially with regard to neighbourhood protection. To this end, it is essential to communicate early with the residential neighbours and involve them in the planning process.

## 6 REFERENCES

- Cities of Making: Cities Report. Brussels, 2018
- Donner C., Prochazka K., Schönfeld M.: Stadtplanung und Stadtentwicklung. In: Holoubek M., Madner V., Pauer K.: Recht und Verwaltung in Wien, pp. 473-503. Vienna, 2014.
- Emberger G., Pfaffenbichler P.: Equidistance: Evidence of the Influence of Parking Organization on Mode Choice. In: Knoflacher H., Öcalir-Akinal E.: Engineering Tools and Solutions for Sustainable Transportation Planning, pp. 129-150. Hershey/USA, 2017.
- Frey H., Laa B., Haselsteiner E., Madner V., Grob L.-M., Schwaigerlehner K.: The Vertical Urban Factory Concept and Sustainable Transport – Prototypes for European Cities. In: Journal of Road and Traffic Engineering. (in press).
- Greater London Authority: The London Plan – Chapter 4: London's economy. London, 2016.
- Grob L.-M.: Nutzungsmischung – Rechtsfragen der Durchmischung von Betriebs- und Wohnnutzungen. Master thesis, WU Vienna, 2018.
- Haselsteiner E., Madner V., Frey H., Grob L.-M., Laa B., Schwaigerlehner K.: VERTICALurbanFACTORY – Innovative Konzepte der vertikalen Verdichtung von Produktion und Stadt. In: Berichte aus Energie- und Umweltforschung, Endbericht. Available: (after end of project) at: <https://nachhaltigwirtschaften.at/de/sdz/projekte/vertical-urban-factory.php>, Vienna, 2019.
- Knoflacher H.: A new way to organize parking: the key to a successful sustainable transport system for the future. In: Environment & Urbanization, Vol. 18, Issue 2, pp. 387-400. Vienna, 2006.
- Madner V., Grob L.-M.: Potentiale der Raumplanung für eine klimafreundliche Mobilität. In: juridikum, Issue 4, pp. 521-532. Vienna, 2019.
- Moritz R.: Kurzkomentar – Bauordnung für Wien. Vol. 6. Vienna, 2019.
- Parikesit D.: Zusammenhang zwischen Verkehrsinfrastrukturangebot und Ortswahl und seine Auswirkung auf den Energieverbrauch im Verkehrssystem. Dissertation, TU Vienna, 1996.
- Senatsverwaltung für Wirtschaft, Energie und Betriebe: Industriestadt Berlin – Masterplan 2018-2021. Berlin, 2018.
- Vienna City Administration, Municipal Department 18 (MA 18) – Urban Development and Planning: STEP 2025 – Urban Development Plan Vienna. Vienna, 2014.
- Vienna City Administration, Municipal Department 18 (MA 18) - Urban Development and Planning: Fachkonzept Produktive Stadt. In: Werkstattberichte der Stadtentwicklung Wien, Issue 171. Vienna, 2017.